

# EXCITEBIKE™

INSTRUCTION BOOKLET



PROGRAMMABLE  
SERIES



Nintendo of America Inc.  
P.O. Box 957, Redmond, WA 98052 U.S.A.

PRINTED IN JAPAN

*Look for this seal on all software and accessories for your Nintendo Entertainment System. It represents Nintendo's commitment to bringing you only the highest quality products. Items not carrying this seal have not been approved by Nintendo, and are not guaranteed to meet our standards of excellence in workmanship, reliability and most of all, entertainment value.*



Thank you for selecting the Nintendo® Entertainment System™ Excitebike™ Pak.

#### **OBJECT OF THE GAME/GAME DESCRIPTION**

Excitebike is part of Nintendo's Programmable series featuring the exclusive Design mode that allows you to create your own race course for a fresh challenge every time you play. You can also select from 5 different tracks designed by Nintendo and choose to race alone or against other motocross riders. Face crazy curves, hairpin turns and daredevil jumps as you race toward the checkered flag and the Excitebike championship.

Please read this instruction booklet to ensure proper handling of your new game, and then save the booklet for future reference.

#### **1. PRECAUTIONS**

- 1) This is a high precision game. It should not be stored in places that are very hot or cold. Never hit or drop it. Do not take it apart.
- 2) Avoid touching the connectors, do not get them wet or dirty. Doing so may damage the game.
- 3) Do not clean with benzene, paint thinner, alcohol or other such solvents.

**Note:** In the interest of product improvement, the Nintendo Entertainment System design and specifications are subject to change without prior notice.

## 2. NAMES OF CONTROLLER PARTS AND OPERATING INSTRUCTIONS

### Controller 1

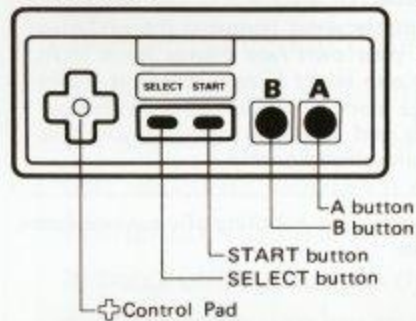

### A Button

This is the accelerator and brake button. Press it and the bike accelerates, let go and the brakes operate. Used for ordinary runs.

Controller 1 — Used for all games

Controller 2 — Not used

### + Control Pad

Use for the landing control of the red bike.

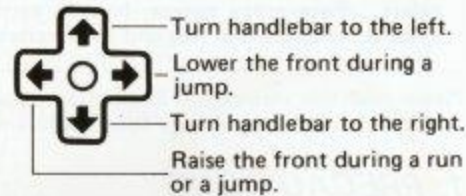

### B Button

This is the turbo button. The engine accelerates quickly and the speed is fast, but if used too much the engine overheats. When the engine overheats, the bike cannot be operated until it cools down.



### SELECT button

Move the checkered flag to line up with the game you wish to play.

- \*The checkered flag also moves with the + control pad.
- \*SELECTION A is a solo run game.
- \*SELECTION B has competing motocross riders.
- \*DESIGN mode is for programming your own course (see instructions).

### START button

Press this button to begin.

### Pause:

If you wish to interrupt play in the middle of a game, press the START button. The pause tone will sound, and the game will stop. Press the START button again when you wish to continue playing. The game will continue from where you left off.



### 3. HOW TO PLAY

\*Before entering the Excitebike race, you must first qualify in the preliminary "challenge" race.

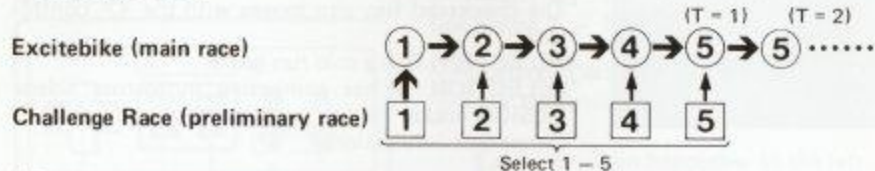

\*Choose the challenge race from 1 to 5 that you wish to start with.

- If you place third or better in the preliminary, you go to the main race of the same number.

[Examples] \* Preliminary race 3rd place → Main Race  
\* Preliminary race 4th place → Game over

- If you place third or better in the main race, you go to the next main race.

[Examples] \* Main Race 1 → Main Race 2 → Main Race 3  
\* Main Race 3 → Main Race 4 → Main Race 5

\* If you place in the main race of Track 5, you can race at Track 5 over and over. The number of times you have raced at Track 5 is indicated at the lower right part of the screen (T = #).

\* If GAME OVER occurs at T = 2 or more, the time necessary to place third will not change unless you first go back to the game menu before playing the next game.

\* The 3RD indicated at the lower left part of the screen is the time necessary to place 3rd.

- SELECTION A is a solo race run. In SELECTION B, motocross riders compete.
- There are two types of motocross riders. One type runs normally and the other type pursues. If a pursuing motocross rider hits you from behind, he falls down. If you hit a motocross rider who is ahead of you from behind, your motocross rider falls down.
- How long the fallen rider rolls depends on the speed he was going just before falling. If the rider falls on a hurdle, the rider rolls to the edge of the hurdle. If your rider falls, press the A button over and over quickly until you return to the race.
- Holding the B button (Turbo button) down too long will overheat the engine. The engine temperature decreases when you pass through the cool zone ( » » mark). Engine condition is indicated by the TEMP meter in the lower central portion of the screen.
- Speed drops if you run off the track or through mud.

## Jumping

- The distance of a jump is determined by the speed before jumping and the angle of the jump. Control this with the  $\oplus$  control pad.
- If the bike lands squarely on both wheels, you can take off quickly. If you land unevenly, your bike will fall.

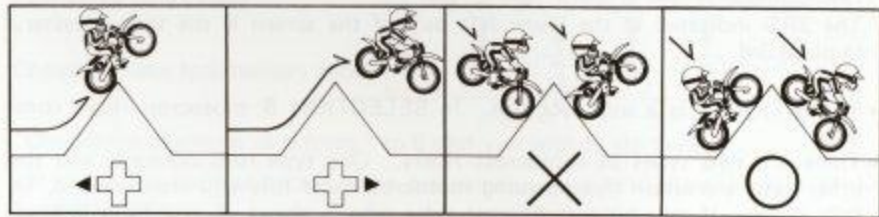

High jump

Low jump



## Wheelies

- \* You can do a wheelie (raise the front wheel in the air) to get over small obstacles.

Wheelie

## Best Time

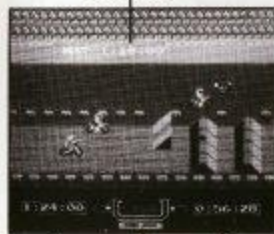

3rd Place Time

Your Time

TEMP Meter (heat)

## Winning time displays

- When you pass the goal line on the first lap, the buzzer sounds and the lap time appears at the center of the screen.
- The lap time necessary to place 3rd is displayed under 3RD at the bottom left of the screen.
- The Best Time is displayed on the fence in the middle of the track for both the preliminary race and the main race.
- The Best Time display will not disappear when you press the reset switch. It will only disappear when the power switch is turned off.

## Techniques

### — How to maintain high speeds —

- \* Try to stay on the track.
- \* Avoid going through the mud.
- \* Since the other riders are also trying to avoid the mud and the track edge, be extra careful when racing alongside another rider.
- \* When jumping over a large obstacle, use the  $\oplus$  control pad to adjust your bike's landing angle correctly. This will prevent you from slowing down upon landing and help you to pick up speed easily.

- \* If you press the  $\oplus$  control pad to lift up the front in the middle of a jump, you can pick up height but not distance. On the other hand, if you press the  $\ominus$  control pad to lower the front you can jump lower and further. Use both of these skillfully.
- \* Press the B button (Turbo button) just before starting off or in front of an obstacle if you want to dash.
- \* You can use your back wheel to knock another rider down.
- \* Make skillful use of the difference between buttons A and B.
- \* Avoid overheating the engine by going through the cool zone (  $\gg$  mark).

## 4. DESIGN MODE



Design mode menu

Design your own original track in the DESIGN mode by setting up different hurdles and specifying how many laps you want.

1. Press the reset switch to recall the game menu.
2. Using the SELECT button or the  $\oplus$  control pad, move the checkered flag to DESIGN and press the START button.
3. The DESIGN mode menu will appear. Move the checkered flag to DESIGN again and press the START button.

Note: Save and Load menu selections are not operable in this game; they have been programmed in for potential product developments.

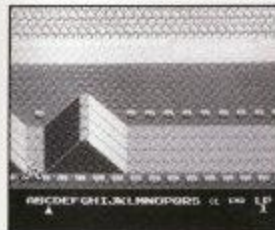

Figure Selection Screen

The Figure selection screen will appear as shown at left. You can then begin to design your course.

### How to design and play on your own original track

1. There are 19 different hurdles you can choose from (A - S). (See listing.)
2. Press the A button to move the motocross rider to where you want to locate a hurdle on the track.
3. Move the  $\blacktriangle$  mark to the letter from A to S corresponding to the hurdle that you wish to set. Press the B button and that hurdle will be set in that location.
4. If you make a mistake and wish to erase a hurdle, move the  $\blacktriangle$  mark to CL (clear). Then, press the B button and the mistake will be erased.
5. The number of hurdles you can set on the track differs according to which hurdles you use and where they are placed. Generally, about 50 are possible.  
\* When the memory is full, FINISH will automatically be displayed.



6. Once the track has been designed, move the ▲ mark to END and press the B button.

\* The best time display will be 0:00:00 and the 3RD prize winning time will be 0:08:00. The first rider's time at the start of the game will be displayed as best time and the 3RD prize winning time will change accordingly.

7. LP (lap) will start to flash. Press the A button or the top/bottom of the control pad to decide the number of laps, and then press the B button to set your choice.





\* The maximum number of laps (LP) is 9.

8. The design mode menu will reappear.













\* Select either PLAY MODE A for a solo race or PLAY MODE B for moto-cross competition, and then press the START button.

9. When you want to end the design mode, move the checkered flag to RESET, and press the START button. The original game list will then be displayed.

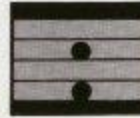
### Hurdle letters for use in original track design

A	B	C	D	E
				

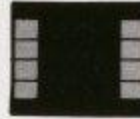
\* (H) is a super jumping ramp.

F	G	H	I	J
				
K	L	M	N	O
				
P	Q	R		S
				

## COMPLIANCE WITH FCC REGULATIONS

This equipment generates and uses radio frequency energy and if not installed and used properly, that is, in strict accordance with the manufacturer's instructions, may cause interference to radio and television reception. It has been type tested and found to comply with the limits for a Class B computing device in accordance with the specifications in Subpart J of Part 15 of FCC Rules, which are designed to provide reasonable protection against such interference in a residential installation. However, there is no guarantee that interference will not occur in a particular installation. If this equipment does cause interference to radio or television reception, which can be determined by turning the equipment off and on, the user is encouraged to try to correct the interference by one or more of the following measures:

- Reorient the receiving antenna
- Relocate the NES with respect to the receiver
- Move the NES away from the receiver
- Plug the NES into a different outlet so that Control Deck and receiver are on different circuits.

If necessary, the user should consult the dealer or an experienced radio/television technician for additional suggestions. The user may find the following booklet prepared by the Federal Communications Commission helpful:

How to Identify and Resolve Radio-TV Interference Problems.

This booklet is available from the U.S. Government Printing Office, Washington, D.C. 20402, Stock No. 004-000-00345-4.

## 90-DAY LIMITED WARRANTY NINTENDO GAME PAKS

### 90-DAY LIMITED WARRANTY:

Nintendo of America Inc. ("Nintendo") warrants to the original consumer purchaser that this Nintendo Game Pak ("PAK") shall be free from defects in material and workmanship for a period of 90 days from date of purchase if a defect covered by this warranty occurs during this 90-day warranty period. Nintendo will repair or replace the PAK, at its option, free of charge.

### To receive this warranty service:

1. DO NOT return your defective Game Pak to the retailer.
2. Notify the Nintendo Consumer Service Department of the problem requiring warranty service by calling: 1-800-422-2602.  
Our Consumer Service Department is in operation from 6:00 A.M. to 6:00 P.M. Pacific Time, Monday through Saturday. Please Do Not send your Pak to Nintendo before calling the Consumer Service Department.
3. If the Nintendo Service Representative is unable to solve the problem by phone, you will be provided with a Return Authorization number. Simply record this number on the outside packaging of your defective PAK, and return your PAK FREIGHT PREPAID AND INSURED FOR LOSS OR DAMAGE, together with your sales slip or similar proof-of-purchase within the 90-day warranty period to:

Nintendo of America Inc.  
NES Consumer Service Department  
4820-150th Avenue N.E.  
Redmond, WA 98052

This warranty shall not apply if the PAK has been damaged by negligence, accident, unreasonable use, modification, tampering, or by other causes unrelated to defective materials or workmanship.

### REPAIR/SERVICE AFTER EXPIRATION OF WARRANTY:

If the PAK develops a problem requiring service after the 90-day warranty period, you may contact the Nintendo Consumer Service Department at the phone number noted at left. If the Nintendo Service Representative is unable to solve the problem by phone, you will be advised of the approximate cost for Nintendo to repair or replace the PAK and will be given a Return Authorization number.

You may then record this number on the outside packaging of the defective PAK and return the defective merchandise, FREIGHT PREPAID AND INSURED FOR LOSS OR DAMAGE, to Nintendo, and enclose a money order payable to Nintendo of America Inc. for the cost quoted you. (Repairs may also be charged on a VISA or MASTERCARD credit card.)

If after personal inspection, the Nintendo Service Representative determines the PAK cannot be repaired, it will be returned and your payment refunded.

### WARRANTY LIMITATIONS:

ANY APPLICABLE IMPLIED WARRANTIES, INCLUDING WARRANTIES OF MERCHANTABILITY AND FITNESS FOR A PARTICULAR PURPOSE, ARE HEREBY LIMITED TO NINETY DAYS FROM THE DATE OF PURCHASE AND ARE SUBJECT TO THE CONDITIONS SET FORTH HEREIN. IN NO EVENT SHALL NINTENDO BE LIABLE FOR CONSEQUENTIAL OR INCIDENTAL DAMAGES RESULTING FROM THE BREACH OR ANY EXPRESS OR IMPLIED WARRANTIES.

The provisions of this warranty are valid in the United States only. Some states do not allow limitations on how long an implied warranty lasts or exclusion of consequential or incidental damages, so the above limitations and exclusion may not apply to you. This warranty gives you specific legal rights, and you may also have other rights which vary from state to state.